

- H1 MountingHole
- H2 MountingHole
- H3 MountingHole
- H4 MountingHole

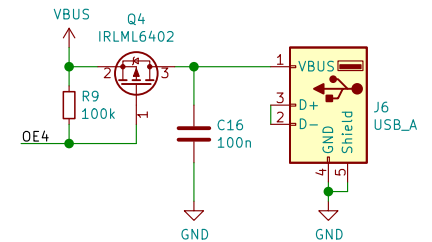

- E1 36pol. Stiffliste, gewinkelt, RM 2,54
- E2 Socket only, order module separately!

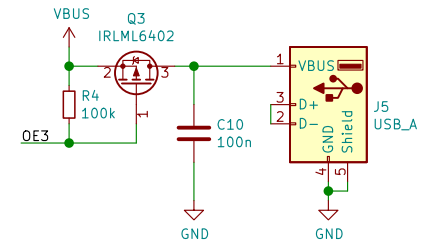
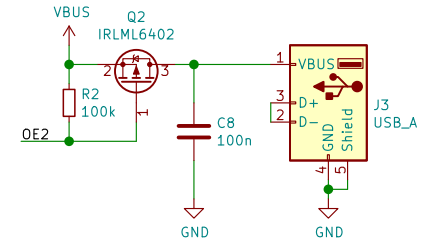
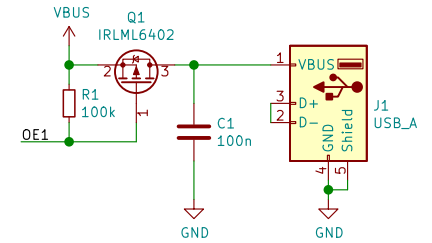
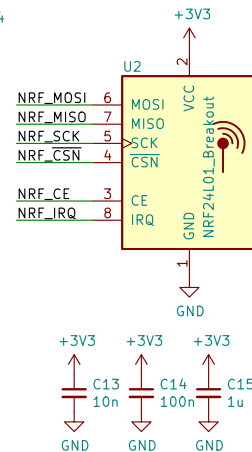
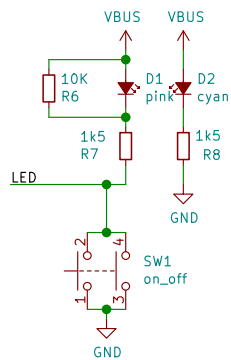
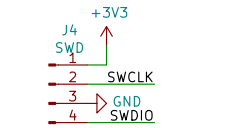
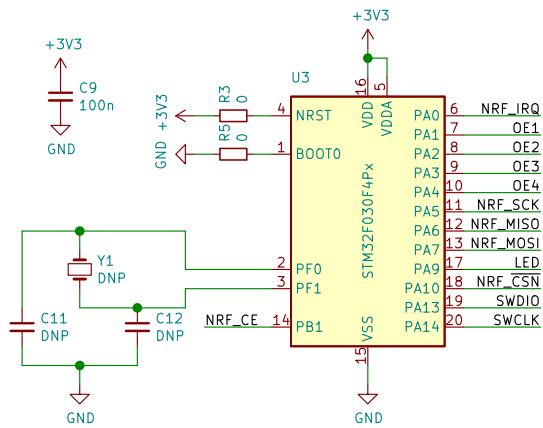

Sheet: /
File: remote.sch

Title:

Size: A4 Date:
KiCad E.D.A. kicad (5.99.0-52-gefbc802f4)

Rev:
Id: 1/1