



A Post-Attack Recovery Architecture for Smart Electricity Meters

Jan Götte <master@jaseg.de>



Fundamentals

The Structure of the Electrical Grid

- Generators
- Transmission Lines
- Switchgear
- Transformers
- Loads



Smart Meter Functionality

- High-resolution Load measurement
- Load switching
→ Demand-Side Response
- Disconnecting “Delinquent” customers
- Smart home gateway



Smart Meter Technology

- Measurement Transformer
 - Application Microcontroller
 - Modem
 - Load switches
 - Display
- Meters in DE are radically different from those in rest of the world:
In DE Modems are external devices!

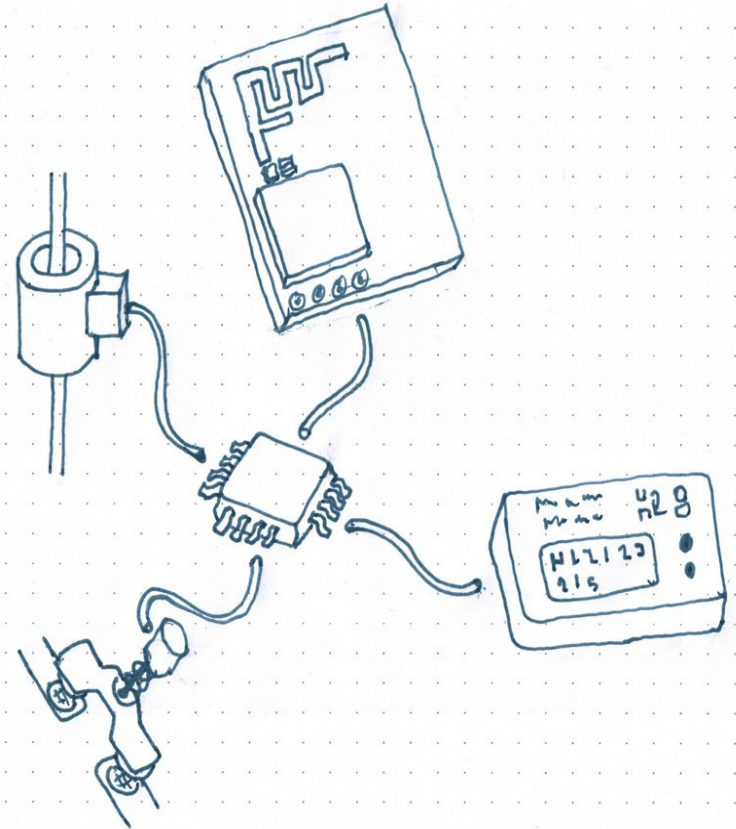

Smart Metering Incentives

- **Better load forecasting for a changing energy market**
 - Renewable Energies increase volatility
 - EV charging amplifies load spikes
- **Profit maximization**
 - Variable tariffs pass through costs
- **Selling data?**



電気さく使用中

さわるな!

DON'T
TOUCH



かんでん ちゅうい
感電注意

設置者

Endpoint Safety & Security

Security in the Distribution Grid

- Large-scale SCADA systems
- Networked
- Physical security is challenging
- Compatibility with decades-old equipment is required!



Hardware and Firmware are Complex

- The line between Microcontroller and System-on-Chip is blurring
 - DMA is ubiquitous
 - MMUs or MPUs are common
 - Coprocessors and Enclaves can be found in both
- Complex HW/FW bundles are integrated
 - Most common: radio modems
 - Also: AI accelerators
 - Also: Complex sensors (e.g. camera/barcode)

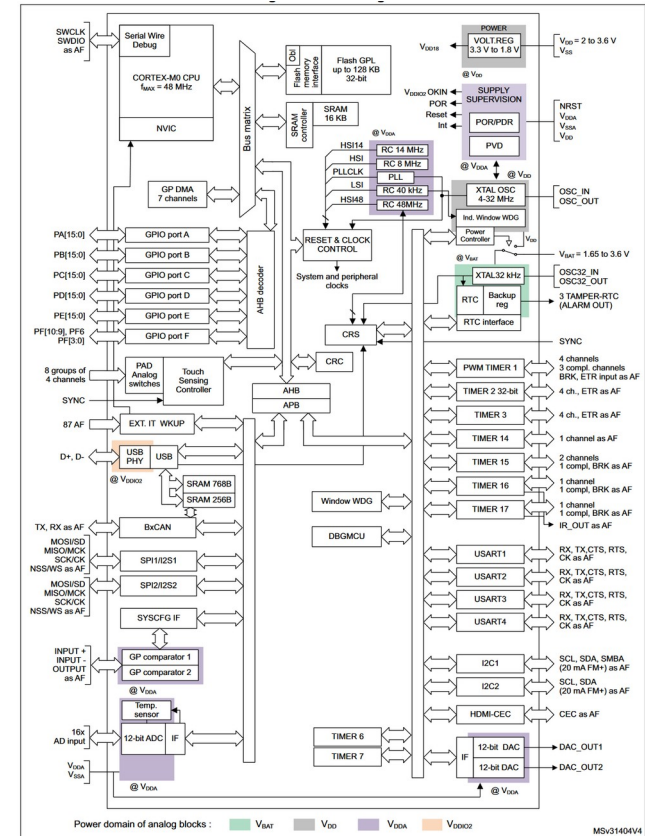

The State of Firmware Security

- Firmware is everywhere
- Firmware is *haaard*
 - Meter Vendor Landis+Gyr spend 36% of their R&D budget on code
- Nobody is good at it
 - Everybody fails: Apple, Samsung, Microsoft, Google
 - μ Cs lack many modern security features





The Safety Reset

The Safety Reset

- **Triggerable over broadcast channel**
 - avoid Warntag-style issue of 1-to-1 comms service overload in case of emergency
- **Hard firmware reset through JTAG**
 - Do not trust either existing firmware or bootloader
- **Golden image: Known-good, all network comms disabled**
 - → True Fail-Safe



Communication along the Grid

Powerline Communication (PLC)

- Transmit at higher frequencies through grid wiring
 - Rundsteuerung: $\sim 300\text{Hz}$ / 10Bd / 50km
 - Narrowband: $\sim 100\text{kHz}$ / 100kBd / 1000m
 - Broadband: $\sim 100\text{MHz}$ / 1Gbit / 50m

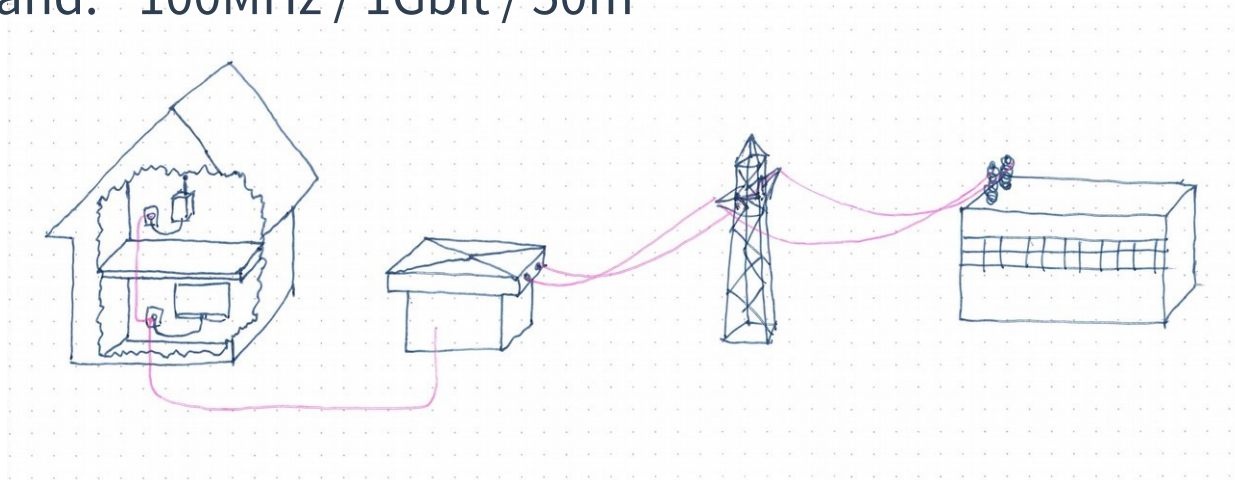

Landline IP

- DSL (Copper phone wiring)
 - DOCSIS (TV cable)
 - Fiber (Ethernet)
- ▶ All have sub-par reliability and require complex contractual architecture



Wireless IP

- **Cellular 2G/3G/4G/5G**
 - Expensive hardware
- **WiMAX etc.**
- **Satellite communication**
 - Expensive, only viable for very remote locations

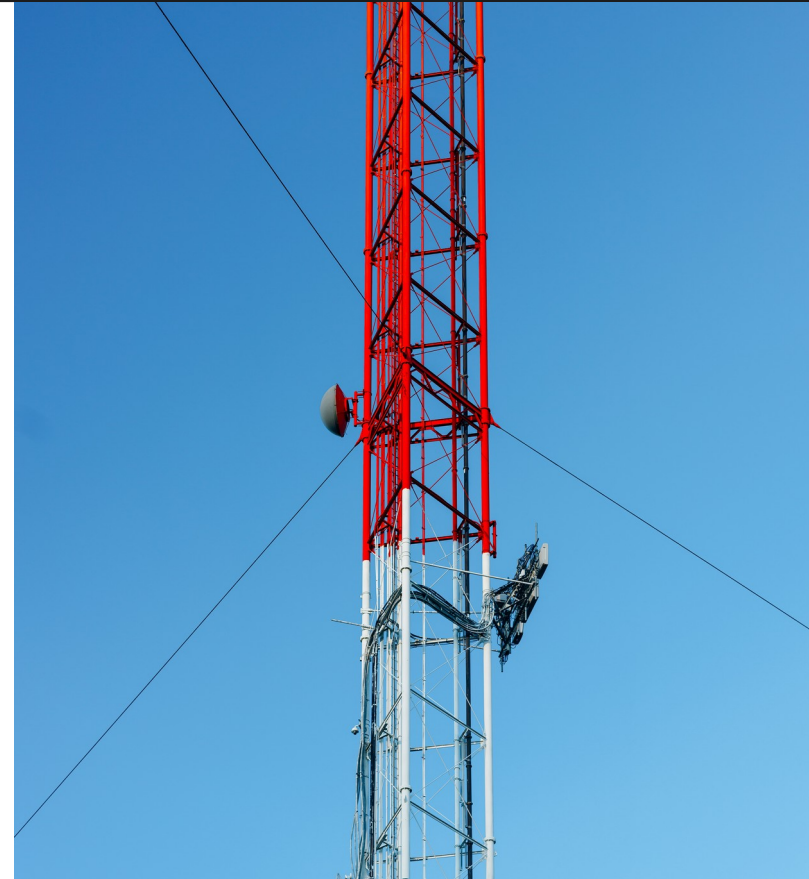

Short-range wireless

- **802.15.4 family**
 - Zigbee, Bluetooth and many proprietary protocols
- **Fully proprietary**
 - Vendor lock-in is possible
- **Frequencies: 2.4GHz, sub-1GHz**
 - Sub-1GHz preferred for range and penetration



The Hack: Grid Frequency Modulation (GFM)

➔ None of these channels work for us: They are too expensive or not reliable under attacks

- Grid frequency can be used for communication
- Grid frequency is load balance dependent
 - Generators/Transmission lines act like spring-coupled oscillators
- Apply a large load, f drops
- Modulate a large load to control Δf



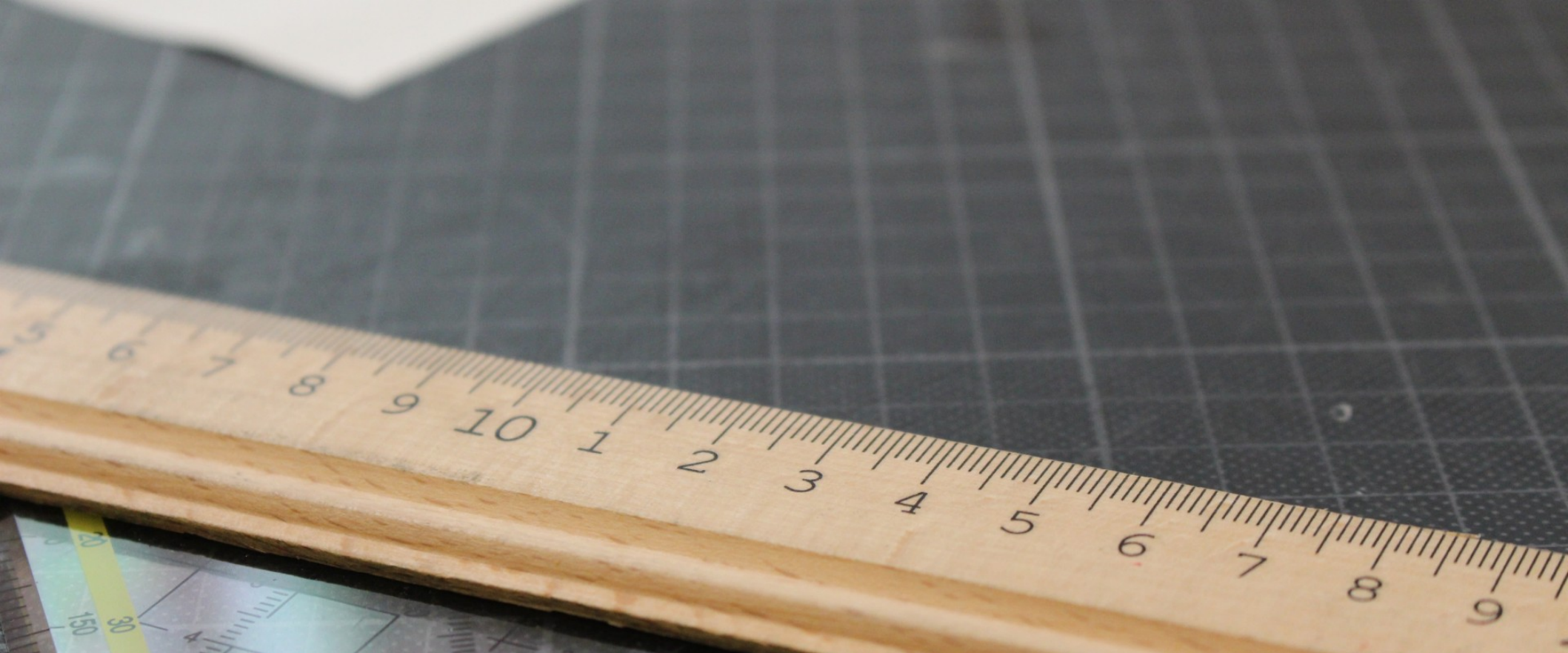

From Grid Frequency to a Reliable Channel

Channel properties

- We know grid frequency is a noisy variable
- Since $f=50\text{Hz}$, any modulation will be *extremely* narrowband
- Grid frequency is equal in all parts of the grid, but has a phase delay
- Now: Characterize noise characteristics
- Later: Characterize channel transmission characteristics through experiments

Characterizing Frequency Noise from Local Measurements

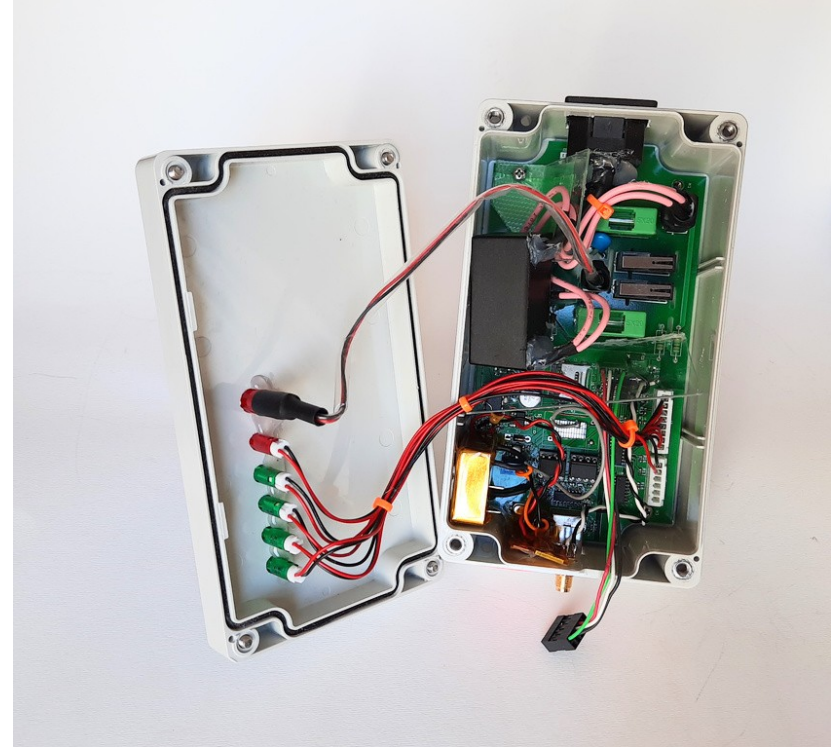
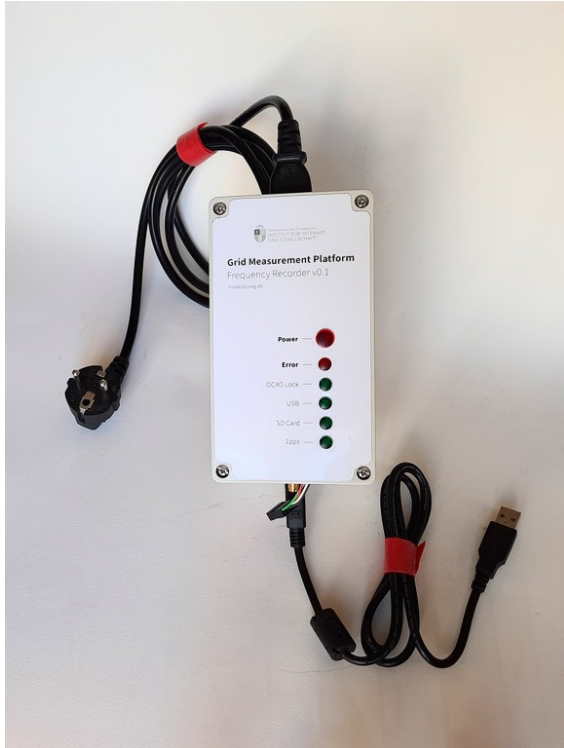

Frequency Measurement Parameters

- Simple, FFT-based algorithm: Run STFT on signal, then fit gaussian to output to precisely locate peak
- Input data 1kSps @12bit
- FFT size 256 samples
- Gaussian window, sigma=16.0

Frequency Measurement Accuracy

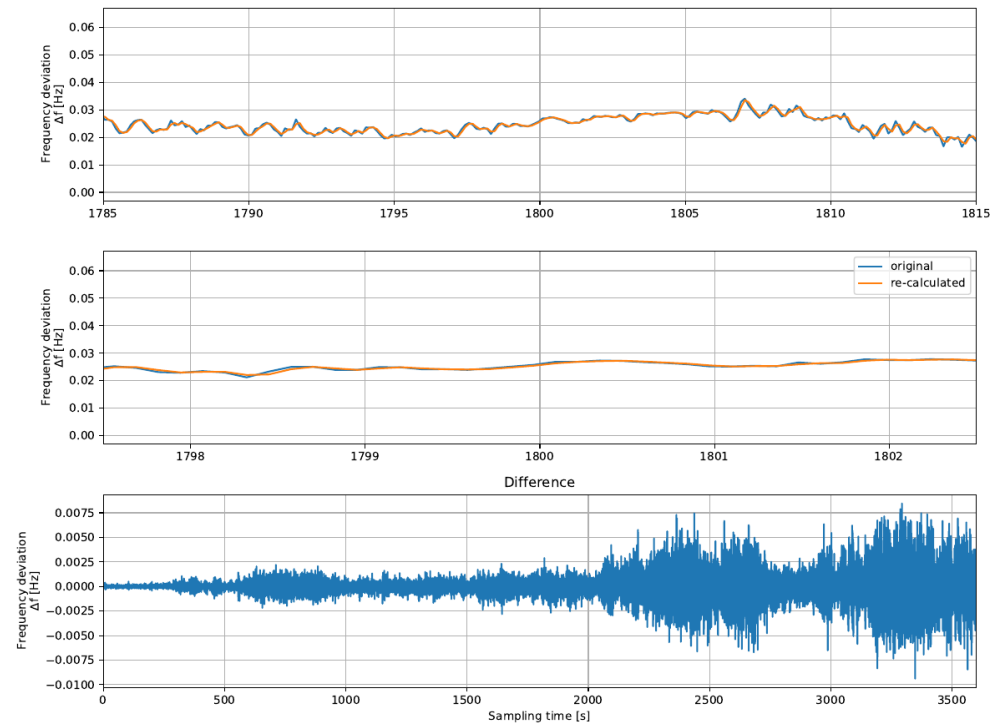
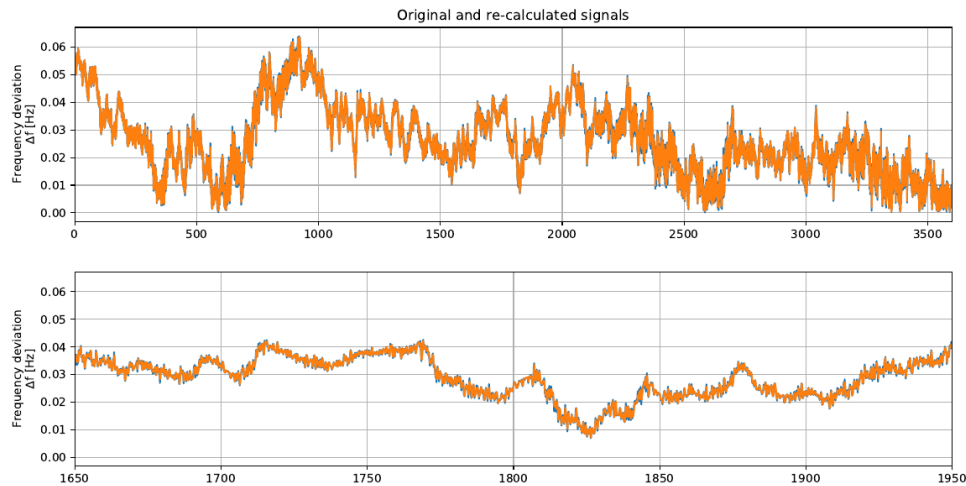

Frequency Noise Measurements

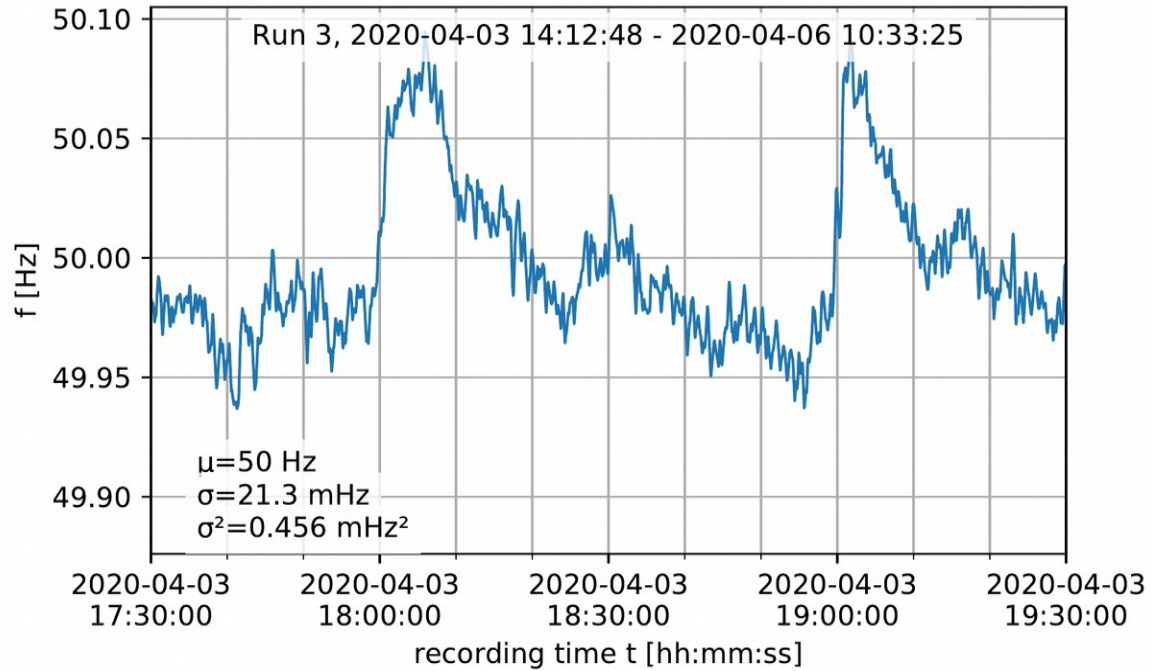

Frequency Noise PSD

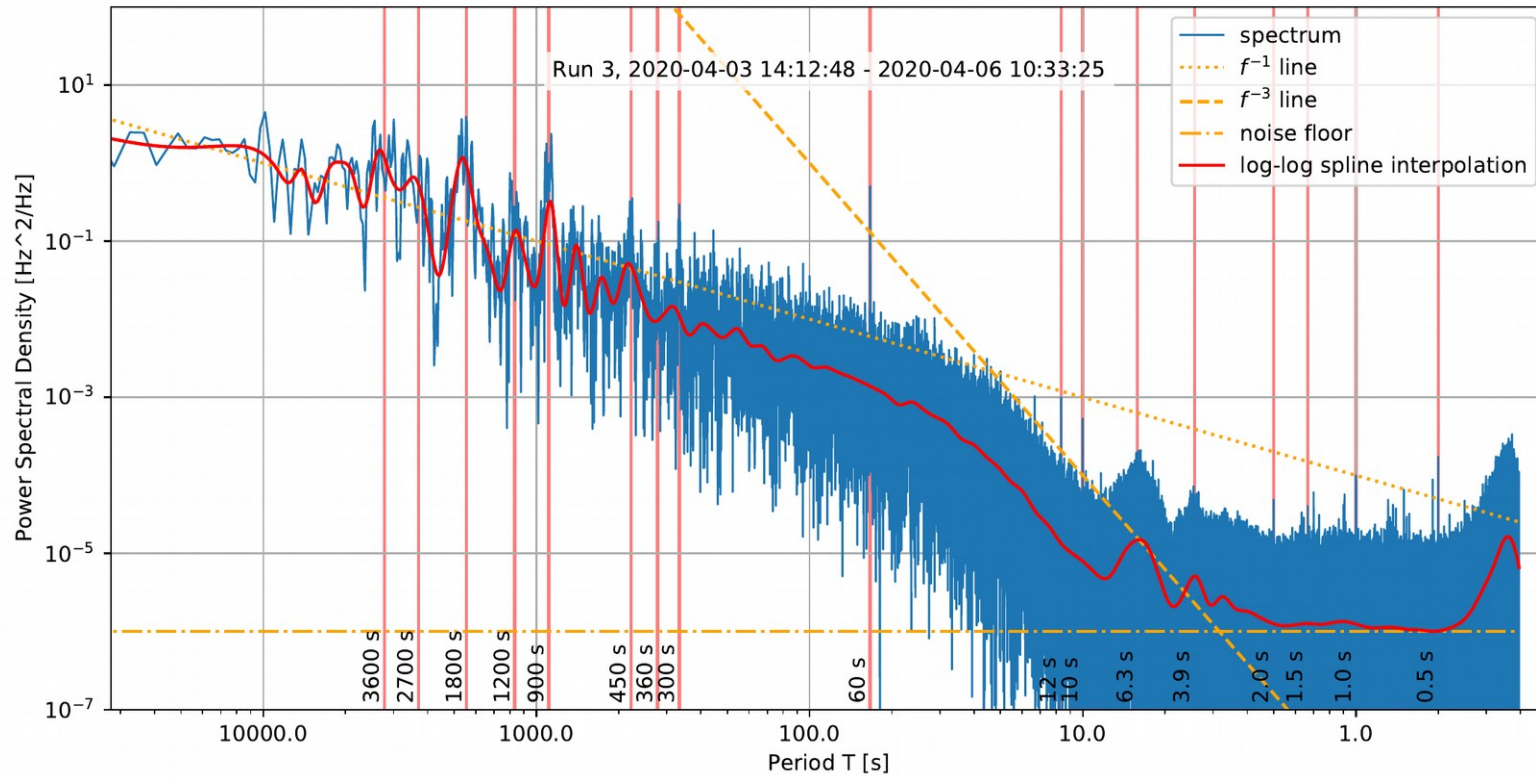

Modulation

- Poor SNR makes UWB necessary
- Limited CPU; Can't be too complex → DSSS is a good compromise
- Long integration times (minutes) are necessary
- Accurate frequency measurement is a limiting factor

DSSS Modulation Parameters: Bit depth

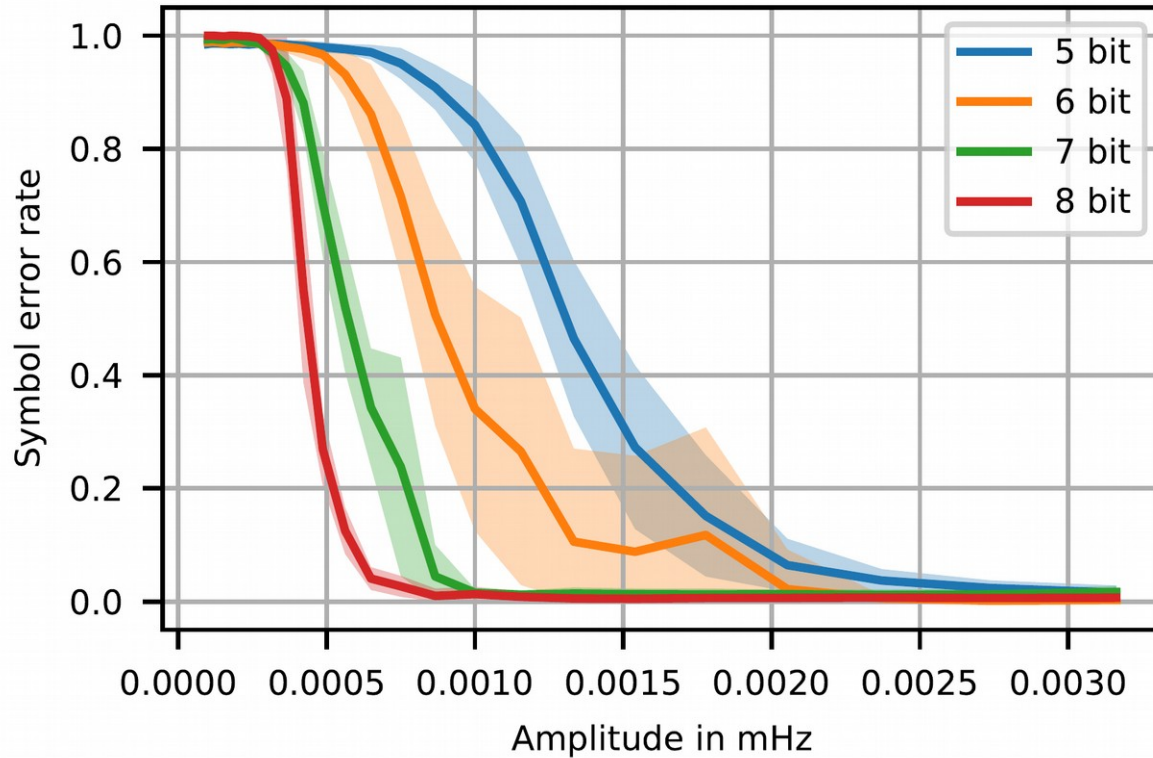

DSSS Modulation Parameters: Detection threshold

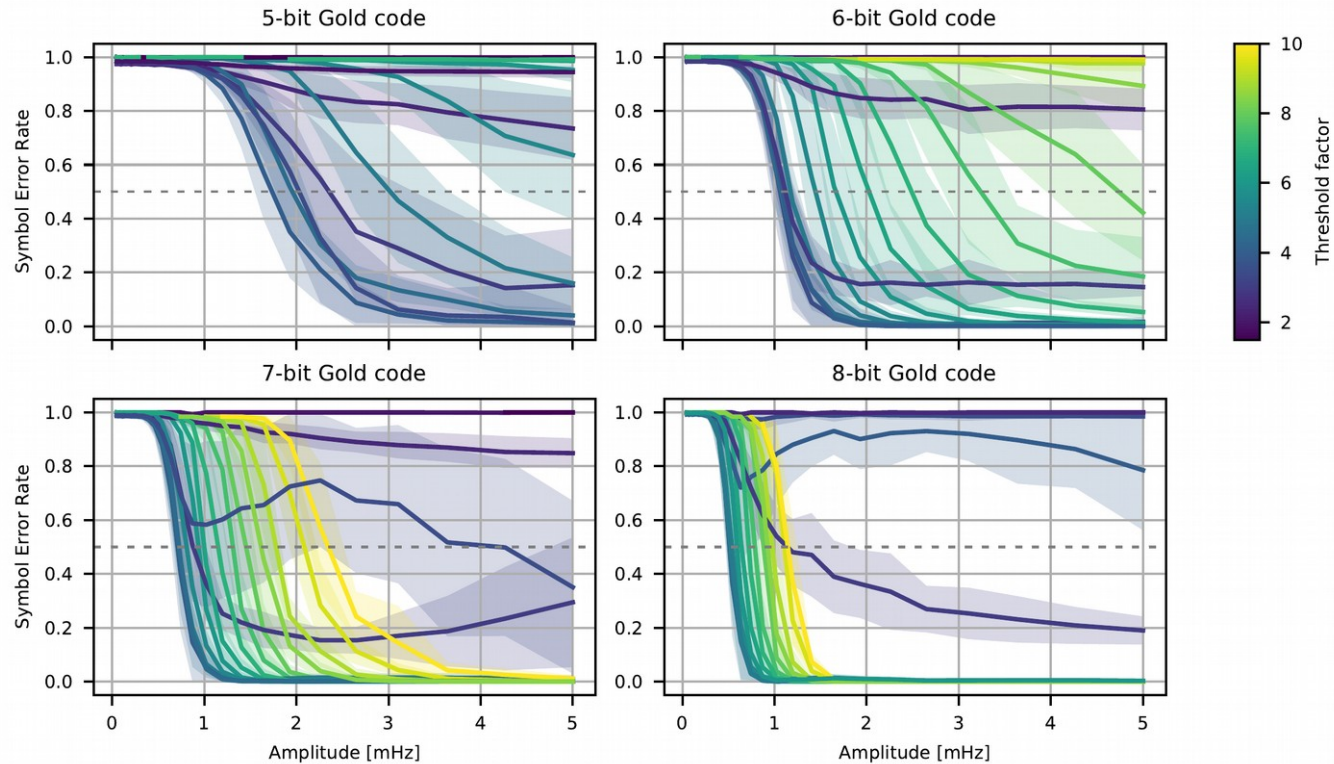

DSSS Modulation Parameters: Chip duration

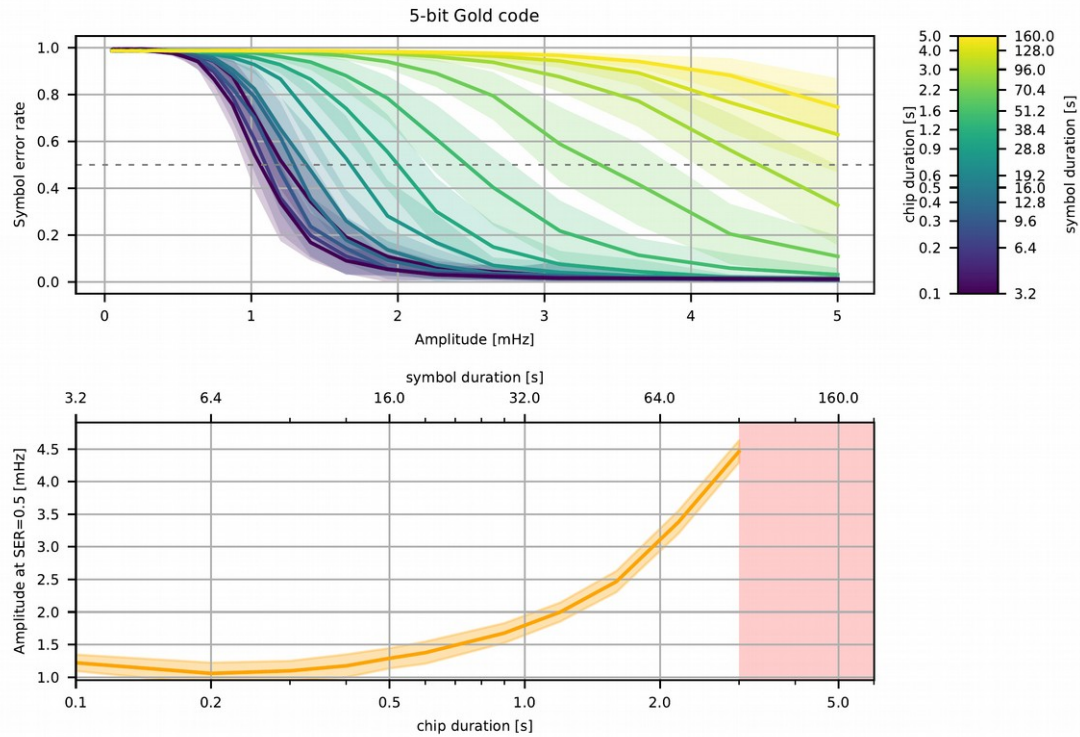

Chosen Modulation Parameters

- **5 bit** Gold Code
- **1s chip** duration
→ 31s symbol duration
- Threshold factor:
5.0× background noise level



Error Correction

- Slow transmission requires small block size
- There is a code size limitation
- It can be simple: Efficiency is good, but not critical

Cryptography

- Non-standard threat model
- Simple setup
- A trivial custom solution is justifiable to save transmission bandwidth
- Simply use pre-computed hash chain
 - Reset controller knows last hash
 - Reset authority knows first hash
 - RA reveals one previous hash to trigger reset
 - Small transmission size, trivial





Testing & Validation

Extensive simulations in Jupyter

- Jupyter allows real-time tinkering with high-quality, interactive graphical plots
- Python code can easily be extracted for running on remote machines
- Plots can easily be exported to publication-quality graphics

Host testing of instrumented firmware

- Firmware implementation of algorithms compiled for host, run from python test fixtures
- Allows for validation of fixed-precision device code against double-precision host prototype

Demonstrator experiments

- Goal: Experimentally verify final optimized set of parameters against synthetic grid voltage trace
- Result: It works :)

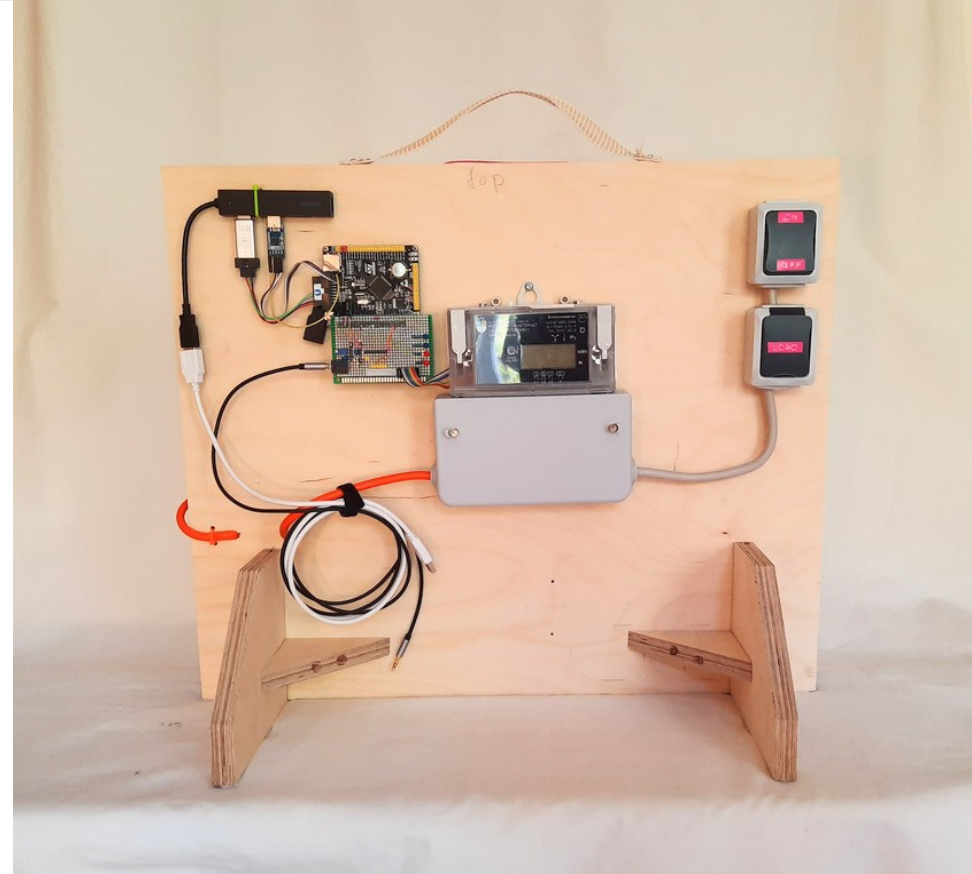

Synthetic Signal Quality

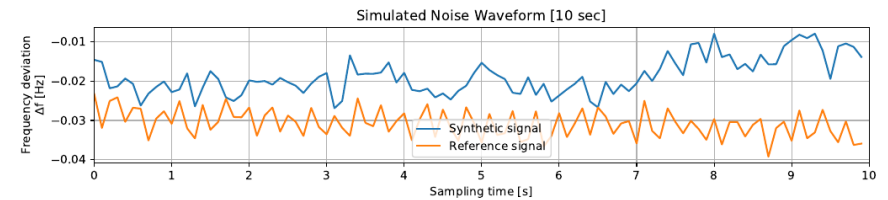
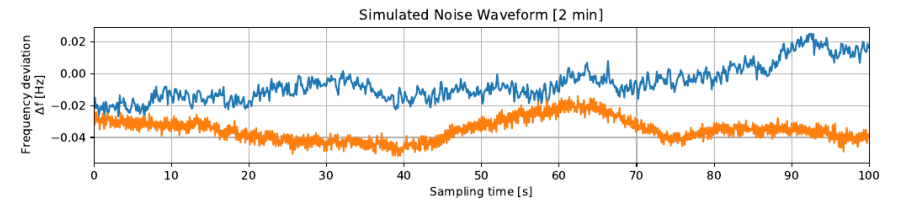
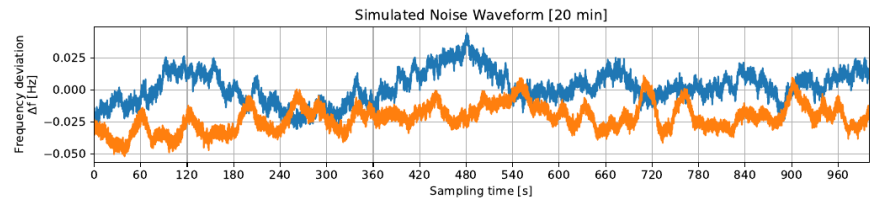
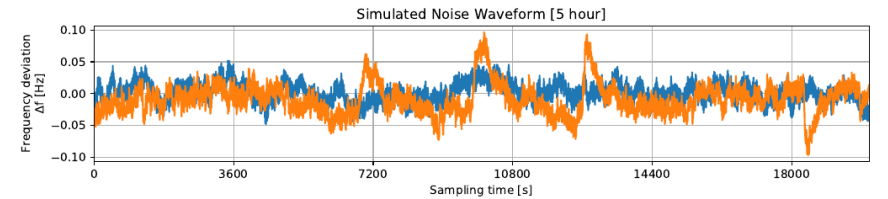
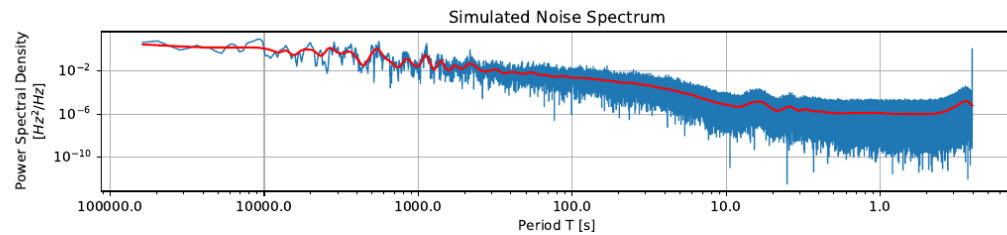



Conclusion

Theoretical analysis results

- FW security is a serious issue
- The attack potential is there
- Safety reset is a viable option
- GFM is viable even during an attack

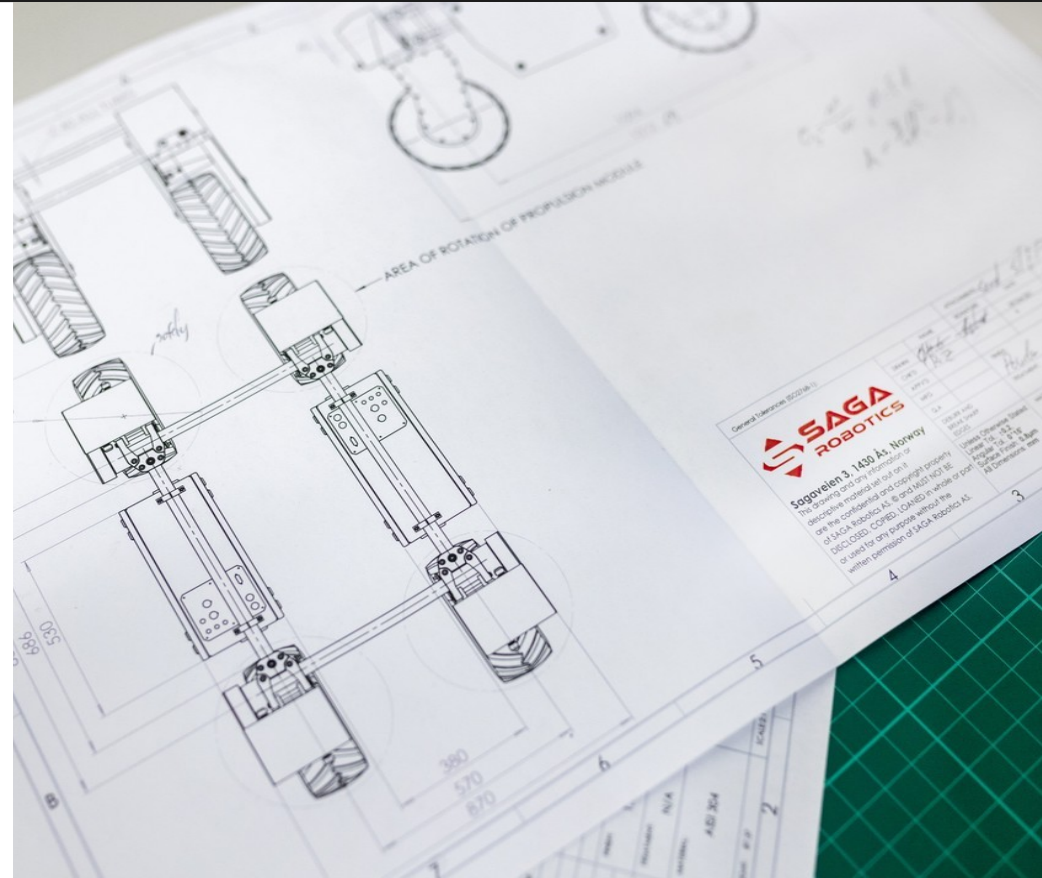

Experimental results

- **Computer simulations using recorded data**
 - Positive result
- **Practical experiments using emulated data**
 - Positive result
- **Conclusion: 20s/bit after ECC is practical**
 - ~15min for complete trigger

Tangible products

- The grid frequency sensor
- The demonstrator
- Extensive simulation notebooks
- Prototype firmware
- Firmware code size analysis tool

➔ All Open Source!!



Q&A



Smart Metering Regulation

- **Multiple competing international standards**
 - **Sometimes no standards at all**
 - **Degree of standardization is variable**
- ▶ **IEC 62056 family slowly subsumes national protocol standards**



Signal Processing Chain

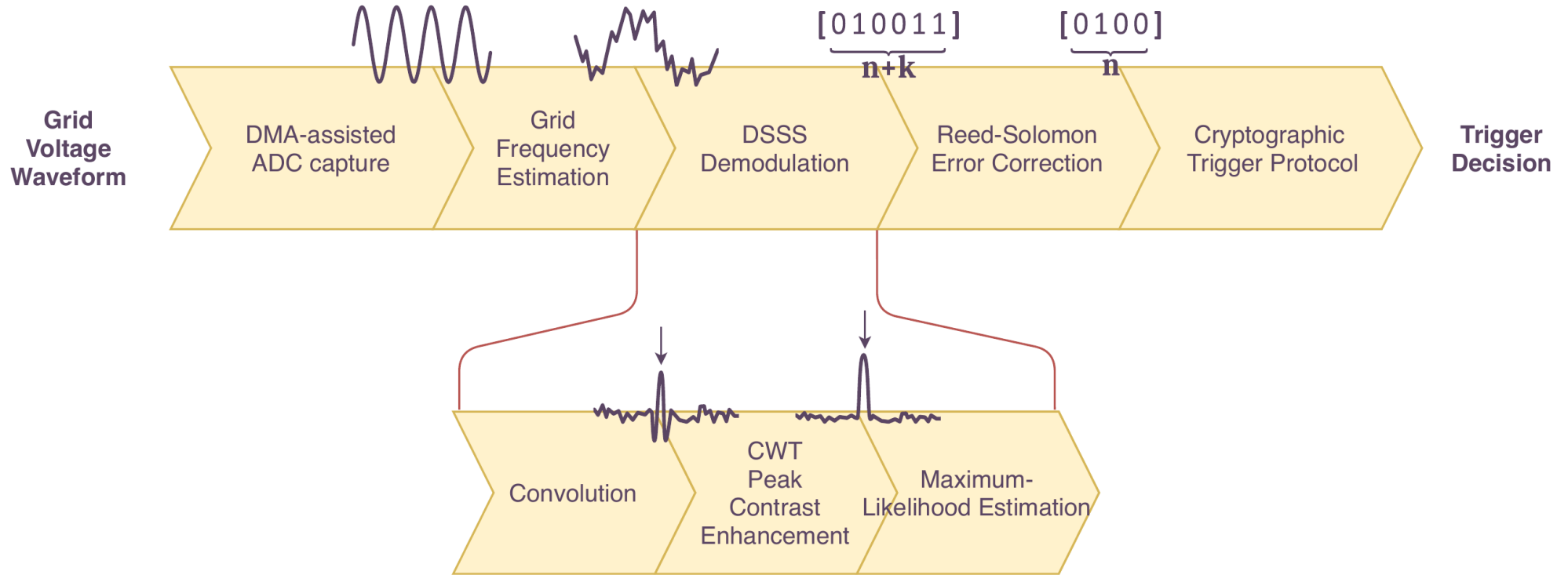

Attacker Prototypes

- **Customers: Electricity theft**
 - Also sold as a service by organized crime
- **Bored teenagers**
- **State actors**



System structure and security

- Exploiting centralized control
- Communication channels exploits
- Control function exploits
- Endpoint exploits

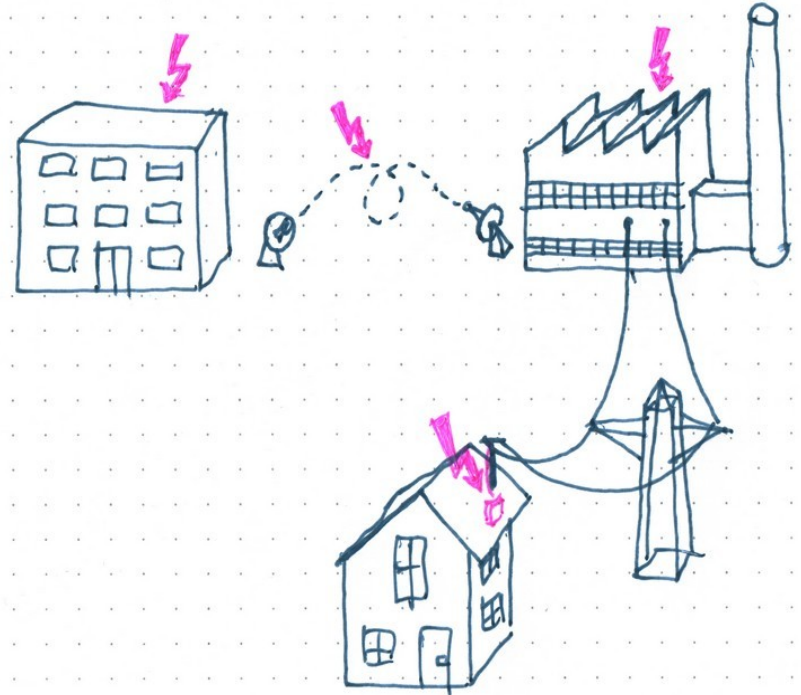

The Structure of the Electrical Grid

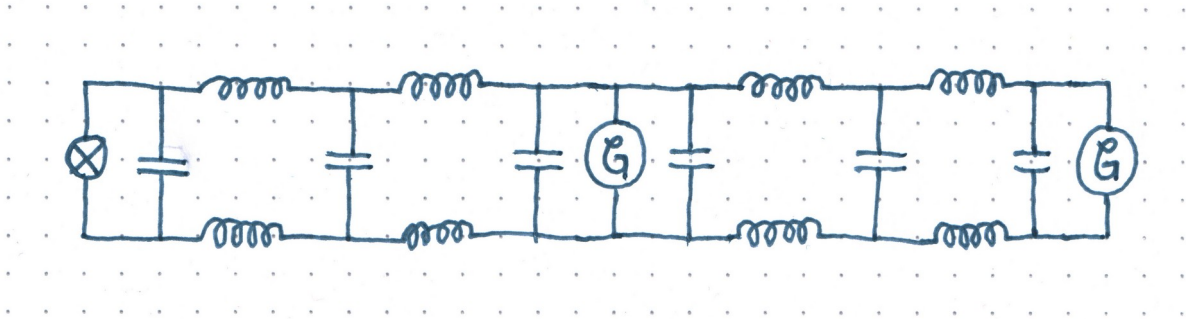
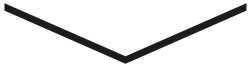
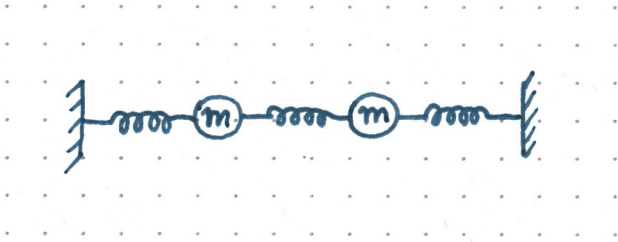

Image Sources (1/3)

1	Title Slide	Jerry Zhang: low-angle photography of electric tower under blue sky during daytime
2	Fundamentals	Atul Vinayak: black escalator in a tunnel
3	The Structure of the Electrical Grid	Iqram-O-dowla Shawon: white and gray industrial machine
3	The Structure of the Electrical Grid	ETA+: gray metal fence on green grass field during daytime
3	The Structure of the Electrical Grid	Jan Huber: green trees near snow covered mountain during daytime
3	The Structure of the Electrical Grid	Dirty Scan: Shoreham Power Station
3	The Structure of the Electrical Grid	Tyler Nix: person holding silver stainless steel electric kettle
4	Smart Meter Functionality	David Edelstein: Maynard Meters
5	Smart Meter Technology	Original work
6	Smart Metering Incentives	Ed Harvey: person holding black and silver smartphone
7	Endpoint Safety & Security	Atul Vinayak: text
8	Security in the Distribution Grid	DynamicWang: woman in gray and white checked overalls standing on metal bars
9	Hardware and Firmware are Complex	ST Microelectronics: STM32F072 datasheet
10	The State of Firmware Security	JESHOOOTS.COM: woman biting pencil while sitting on chair in front of computer during daytime
11	The Safety Reset	Atul Vinayak: person holding clear umbrella across city building during nighttime
12	The Safety Reset	N/A
13	Communication along the Grid	Nicholas Bartos: gray transmission tower during daytime
14	Powerline Communication (PLC)	Original work

Image Sources (2/3)

15	Landline IP	Quino AI: black corded telephone
16	Wireless IP	MILKOVÍ: white and red satellite tower
17	Short-range wireless	Erik Mclean: Person holding black remote control
18	The Hack: Grid Frequency Modulation (GFM)	Fré Sonneveld: black transmission towers under green sky
19	From Grid Frequency to a Reliable Channel	Christian Kaindl: brown wooden ruler
20	Channel properties	N/A
21	Characterizing Frequency Noise from Local Measurements	Original work
22	Frequency Measurement Parameters	N/A
23	Frequency Measurement Accuracy	Original work
24	Frequency Noise Measurements	Original work
25	Frequency Noise PSD	Original work
26	Modulation	N/A
27	DSSS Modulation Parameters: Bit depth	Original work
28	DSSS Modulation Parameters: Detection threshold	Original work
29	DSSS Modulation Parameters: Chip duration	Original work
30	Chosen Modulation Parameters	Keila Hötzel: white notebook
31	Error Correction	N/A
32	Cryptography	Photos Hobby: Light

Image Sources (3/3)

33	Testing & Validation	StellrWeb: white Canon cash register
34	Extensive simulations in Jupyter	N/A
35	Host testing of instrumented firmware	N/A
36	Demonstrator experiments	Original work
37	Synthetic Signal Quality	Original work
38	Conclusion	Markus Spiske: yellow electric sign
39	Theoretical analysis results	ThisisEngineering RAEng: white printer paper with musical notes
40	Experimental results	N/A
41	Tangible products	Shahadat Rahman: shallow focus photography of computer codes
42	Q&A	Kevin Ku: closeup photo of eyeglasses
43	Smart Metering Regulation	Bernd Klutsch: pile of books
44	Signal Processing Chain	Original work
45	Attacker Prototypes	ABDURREHMAN: five electric meters on wall
46	System structure and security	Original work
47	The Structure of the Electrical Grid	Original work